

# High-Reliability and High-Performance Compact Machining Center

# FANUC

## ROBODRILL

### α-DiB5 Plus series

### Standard version / Advanced version



Алматы (7273)495-231  
Ангарск (3955)60-70-56  
Архангельск (8182)63-90-72  
Астрахань (8512)99-46-04  
Барнаул (3852)73-04-60  
Белгород (4722)40-23-64  
Благовещенск (4162)22-76-07  
Брянск (4832)59-03-52  
Владивосток (423)249-28-31  
Владикавказ (8672)28-90-48  
Владимир (4922)49-43-18  
Волгоград (844)278-03-48  
Вологда (8172)26-41-59  
Воронеж (473)204-51-73  
Екатеринбург (343)384-55-89

Иваново (4932)77-34-06  
Ижевск (3412)26-03-58  
Иркутск (395)279-98-46  
Казань (843)206-01-48  
Калининград (4012)72-03-81  
Калуга (4842)92-23-67  
Кемерово (3842)65-04-62  
Киров (8332)68-02-04  
Коломна (4966)23-41-49  
Кострома (4942)77-07-48  
Краснодар (861)203-40-90  
Красноярск (391)204-63-61  
Курск (4712)77-13-04  
Курган (3522)50-90-47  
Липецк (4742)52-20-81

Россия +7(495)268-04-70

Магнитогорск (3519)55-03-13  
Москва (495)268-04-70  
Мурманск (8152)59-64-93  
Набережные Челны (8552)20-53-41  
Нижний Новгород (831)429-08-12  
Новокузнецк (3843)20-46-81  
Ноябрьск (3496)41-32-12  
Новосибирск (383)227-86-73  
Омск (3812)21-46-40  
Орел (4862)44-53-42  
Оренбург (3532)37-68-04  
Пенза (8412)22-31-16  
Петрозаводск (8142)55-98-37  
Псков (8112)59-10-37  
Пермь (342)205-81-47

Казахстан +7(7172)727-132

Ростов-на-Дону (863)308-18-15  
Рязань (4912)46-61-64  
Самара (846)206-03-16  
Санкт-Петербург (812)309-46-40  
Саратов (845)249-38-78  
Севастополь (8692)22-31-93  
Саранск (8342)22-96-24  
Симферополь (3652)67-13-56  
Смоленск (4812)29-41-54  
Сочи (862)225-72-31  
Ставрополь (8652)20-65-13  
Сургут (3462)77-98-35  
Сыктывкар (8212)25-95-17  
Тамбов (4752)50-40-97  
Тверь (4822)63-31-35

Киргизия +996(312)96-26-47

Тольятти (8482)63-91-07  
Томск (3822)98-41-53  
Тула (4872)33-79-87  
Тюмень (3452)66-21-18  
Ульяновск (8422)24-23-59  
Улан-Удэ (3012)59-97-51  
Уфа (347)229-48-12  
Хабаровск (4212)92-98-04  
Чебоксары (8352)28-53-07  
Челябинск (351)202-03-61  
Череповец (8202)49-02-64  
Чита (3022)38-34-83  
Якутск (4112)23-90-97  
Ярославль (4852)69-52-93

<https://fanuc.nt-rt.ru/> || [fcu@nt-rt.ru](mailto:fcu@nt-rt.ru)

High-Reliability and High-Performance  
Compact Machining Center

# FANUC ROBODRILL $\alpha$ -DiB5 Plus



\*1  
\*2

$\alpha$ -D14/21LiB5 Plus

$\alpha$ -D14/21/28LiB5<sub>ADV</sub> Plus Y500

X-axis stroke : 700 mm



\*1



\*1

$\alpha$ -D14/21MiB5 Plus

$\alpha$ -D14/21/28MiB5<sub>ADV</sub> Plus

X-axis stroke : 500 mm

$\alpha$ -D14/21SiB5 Plus

$\alpha$ -D14/21SiB5<sub>ADV</sub> Plus

X-axis stroke : 300 mm

\*1 Photo when DDRiB mounted

\*2 Photo when front double doors option mounted

# series

## High-Performance of Machining

---

High-speed, high-precision and fine surface machining by high-rigidity machine structure and latest CNC functions

Utilization in various fields by wide variety of spindle

High-productivity by stable machining with thermal displacement compensation function

## Maximizing Uptime

---

Long-term stable operation by high-reliability, high-maintainability and preventive maintenance functions

Reducing power consumption including peripherals by energy saving technologies

Operation condition monitoring and analysis by **ROBODRILL-LINK<sup>i</sup>**

## Ease of Use

---

Excellent operability of exclusive screens with human-centered design

Easy to connect peripherals or network by high-expandability and user-interface

Easy integration with FANUC Robot by automation supporting functions

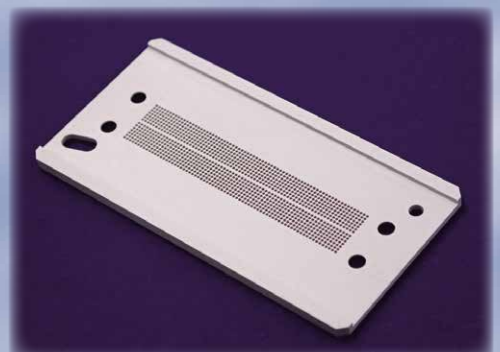
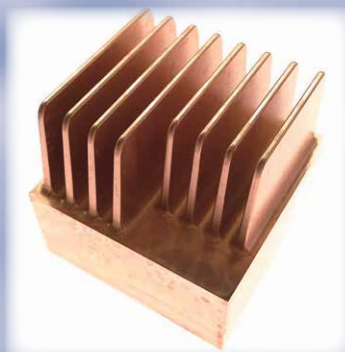

# Features of $\alpha$ -D*i*B5 **Plus** series Advanced version

## New product $\alpha$ -D28L*i*B5<sub>ADV</sub> **Plus** Y500

- Y-axis stroke 500mm
  - Stroke extension by 100mm to meet the needs of combined and large-sized parts machining
  - Table depth also extended to 500mm to accept larger fixture
  - Machine length extension only by 65mm by applying multi-steps telescopic cover, etc.
  - Approach from front door to table only 180mm
- Tool storage capacity 28 tools \*
  - Large-sized turret to enhance process integration
  - Max. tool mass 4kg, Max. total tool mass 46kg
  - Tool change time 0.7s (1.5kg setting, Tool to Tool)
    - \* Option for X-axis stroke 500mm and 700mm of Advanced version
- Level-up of Z-axis feed
  - Rapid traverse rate 60m/min, Max. acceleration 2.2G
  - Cycle time reduction in drilling and tapping
- **DDR-TL*i*B** raised version (option)
  - Max. turn diameter 540mm to make the most of Y-axis stroke 500mm

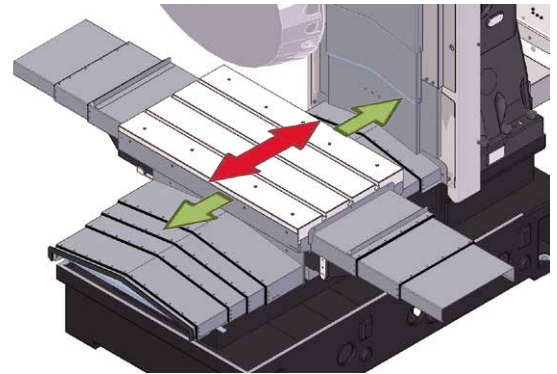

Extension of Y-direction stroke and table size



Large-sized turret for 28 tools



\* Photo when optional front double doors and basic top cover are mounted

$\alpha$ -D28L*i*B5<sub>ADV</sub> **Plus** Y500

## Expanding application range

- Expanding machining area
  - Z-axis stroke extension to 400mm improves approach to the machining point
  - Less interference structure with the large fixture
- Table load capacity 400kg \*
  - Applicable to large fixture and workpiece
    - \* Max 200kg for X-axis stroke 300mm
- High column (option) \*
  - Column raising up to 400mm depending on fixture is available for wide range of application
    - \* Max 200mm for X-axis stroke 300mm
- Servo turret
  - Max. tool weight 4kg enables larger cutting tool
  - Tool change time reduction by 0.2s compared with standard version ROBODRILL

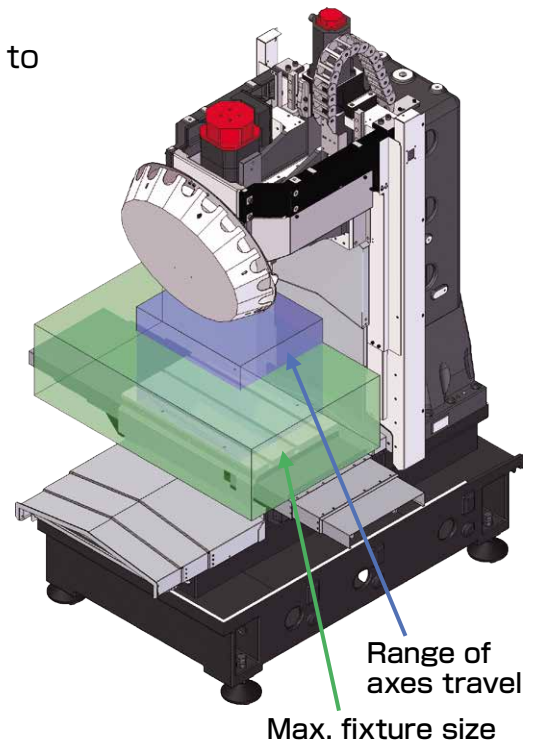

## Excellent chip countermeasure

- Z-axis telescopic cover
  - Higher durability by newly applying telescopic cover
  - Compact design for less interference
- Y-axis front mountain-shaped telescopic cover \*
  - Smooth coolant flow improves chip evacuation
  - Enhanced covering against chips and coolant
    - \* Applied except for X-axis stroke 300mm
- X-axis telescopic cover with 3 pieces \*
  - 3 pieces cover is applied as standard
  - Higher reliability by the improvement of structure
    - \* Applied except for X-axis stroke 300mm

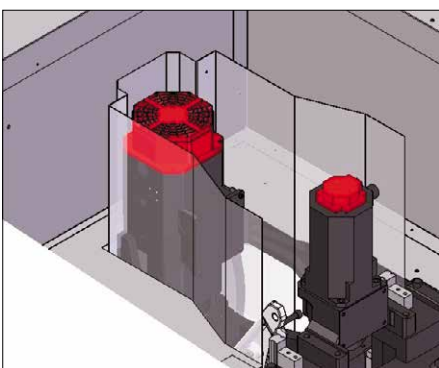
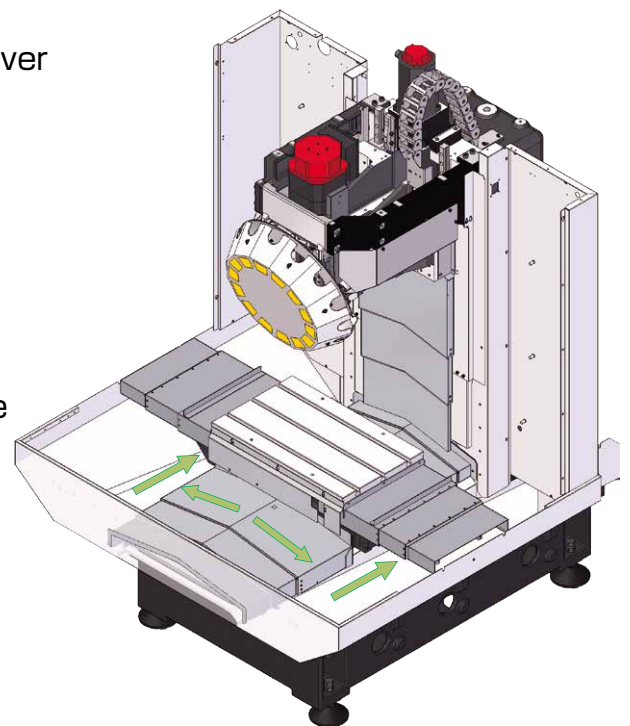

Enhanced cover around spindle motor

- Enhanced cover around spindle motor (option) \*
  - Certain separation of spindle mechanism from machining area protects intrusion of chips and coolant and achieves high-sustainability

\* Basic top cover (option) is necessary

# Features of $\alpha$ -DiB5 Plus series

## Cycle time reduction technologies to achieve high-productivity

- Machining mode setting function 2
  - New machining modes with latest CNC functions realize further cycle time reduction, high-precision machining and fine surface machining
  - Intuitive and operable screen helps to select and adjust the optimum machining mode



- Level-up of table loading capacity setting
  - Easy and exact tuning by automatic setting function
  - Finer loading capacity setting in 1 kg to achieve optimized acceleration/deceleration

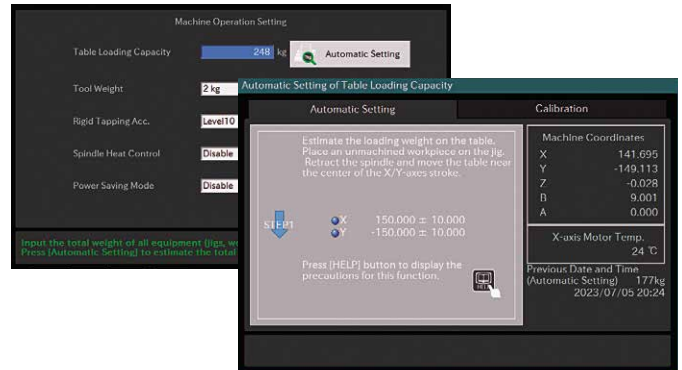

- Canned cycle for ROBODRILL
  - Programming techniques for cycle time reduction and machining quality improvement on ROBODRILL are functionalized
  - Useful G-codes such as fast deep drilling cycle, circle milling cycle, deburring cycle, tool change cycle, etc. are ready to use

- Fast Cycle-time Technology
  - The latest CNC functions effective for cycle time reduction such as smart overlap function, smart rigid tapping function, etc. are applied
- Other technologies
  - Overlap of the ATC and table motion
  - High-speed SKIP interface to reduce measurement time with touch probe
  - Tapping spindle with low inertia and high acceleration/deceleration for effective Aluminum machining (option)

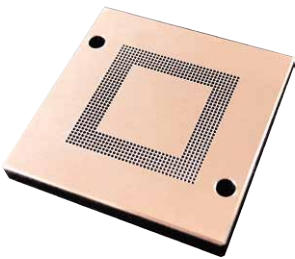

Fast deep drilling example  
( $\Phi$ 0.4mm x 720 holes)



Deburring cycle example

## Application example of cycle time reduction



Example of indexing application by **DDR-TiB**

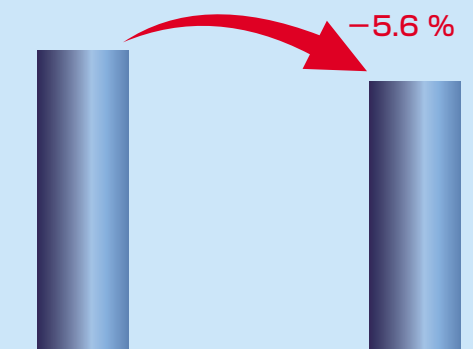

$\alpha$ -D21LiB5<sup>ADV</sup> Plus 225 s       $\alpha$ -D28LiB5<sup>ADV</sup> Plus Y500 212 s

## Technology for power saving

- Energy saving setting screen
  - Energy saving setting for Robodrill and option devices is available
    - Automatic power off function
    - Energy saving control of screen saver, illumination, coolant pumps, lubrication, and spindle air purge
    - Energy saving mode of servo system and rigid tapping\*
- \*Motor output at acceleration/deceleration is limited to reduce consumption. Cycle time becomes longer relatively
- Sleep function
  - Reducing power waste during stand by, by cutting off power supply to servo motors and optional devices
- Mist collector control function (option)
  - Energy saving control of mist collector, one of the most power consuming peripherals, can be easily achieved with dedicated interface unit
- Power consumption monitor
  - Energy saving effect can be confirmed by the consumption record
  - Consumption record can be collected by **ROBODRILL-LINK*i***
- Power regeneration
  - Power regeneration function that regenerates the energy at deceleration of motors has been adopted since 1994.
  - Regenerated power is used at other equipment and contributes to reduce power consumption of entire factory

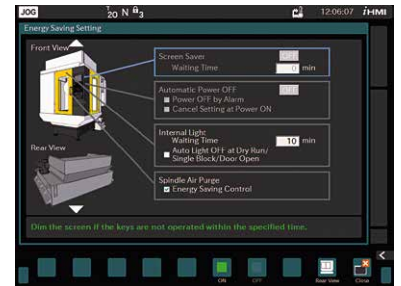

Energy saving setting screen



Power consumption monitor

## Network function

- On-board multifunction Ethernet
  - Fast Ethernet port is available for high-speed data transfer. Together with standard Ethernet port, CNC can be connected to two different networks at the same time
  - Various field network protocols such as FL-net, EtherNet/IP, PROFINET, Modbus/TCP are supported
- Field network (option)
  - Other field network protocols such as CC-Link, DeviceNet, PROFIBUS-DP are also available by adding option board on CNC
- Network manager screen
  - Operability improvement by unifying screens for network settings
  - Connection guidance helps to connect PC software such as Program transfer tool or FANUC LADDER III
  - Detailed setting screen supports multiple network connection assignment

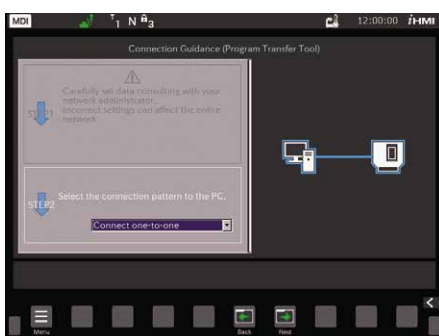

Connection guidance screen

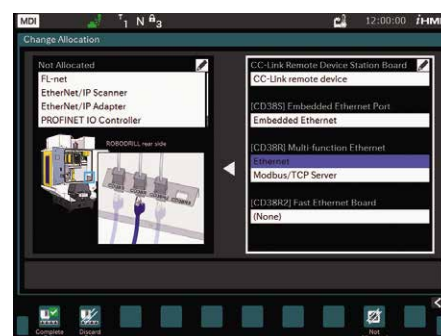

Change allocation screen

# High-Performance of Machining

## Wide variety of high-speed and high-power spindle

### ● High-power spindle

- High-rigidity machine structure and optimized combination of spindle unit and spindle motor enables excellent ability in milling in addition to the high-speed drilling and tapping

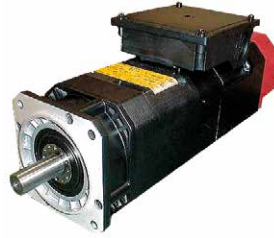

High power spindle motor

### ● Optimum spindle selectable according to application

Spindle spec.	Max. speed	Application
Standard	10000 min <sup>-1</sup>	Wide range of machining use
High-torque		Heavy machining of steel parts (Max. 100N·m)
High-acceleration		High-speed and high-efficiency machining of aluminum parts
Tapping	12000 min <sup>-1</sup>	High-cycle light machining of aluminum parts
High-speed	24000 min <sup>-1</sup>	High-speed machining with small diameter tools

\* BBT30 (BIG PLUS) tool taper (option): Available for all spindle spec.

\* Center through coolant spindle (option): Available for all spindle spec.

Withstand pressure 7MPa

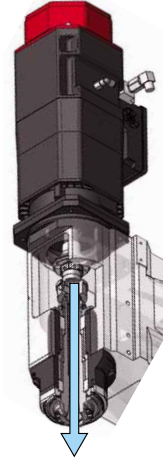

Center through spindle

### Spindle output characteristic

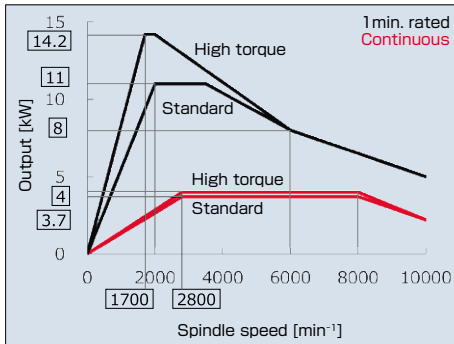

Standard / High-torque

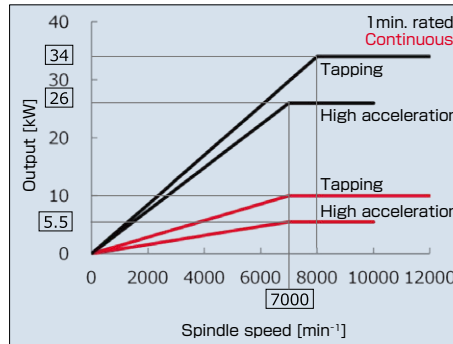

High-acceleration / Tapping

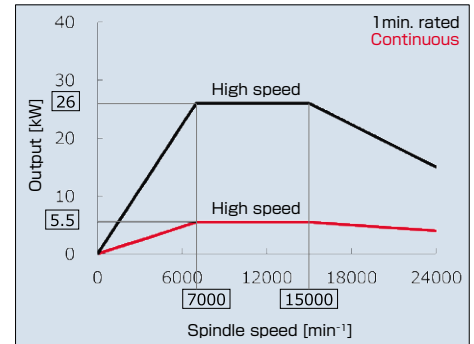

High-speed

### Spindle torque characteristic

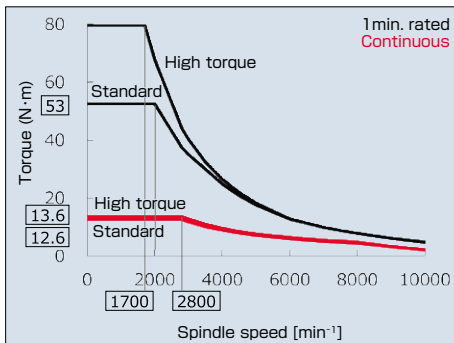

Standard / High-torque

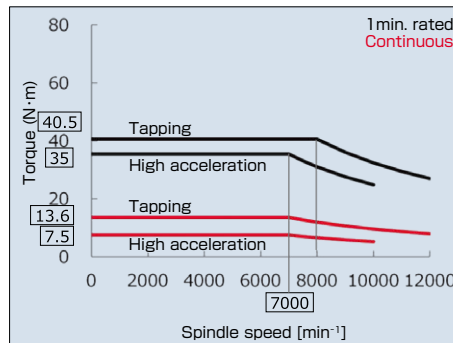

High-acceleration / Tapping

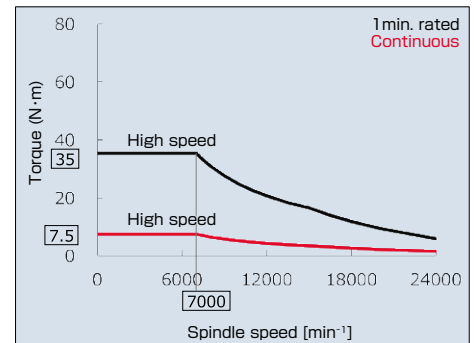

High-speed

\* Characteristics of High-torque, High-acceleration, and High-speed spindles are for high-power version



## High-precision and fine surface machining

- Fine surface technology
  - SERVO HRV+ control  
Achieving high-responsiveness by optimized electrical control
  - High-precision program command  
Machining programs with least unit 0.1  $\mu\text{m}$  are executed exactly
  - Smooth tolerance+ control  
Achieving fine surface by smoothing tool path with short line segments and reducing steps between adjacent paths

Further improvement of machining accuracy and surface quality by applying the latest CNC and Servo functions

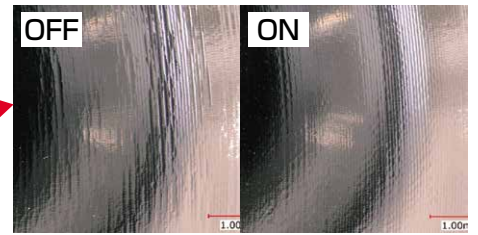
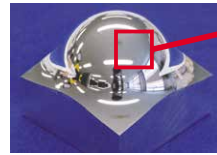

Example of high precision program command  
\* Program with least unit 0.1  $\mu\text{m}$

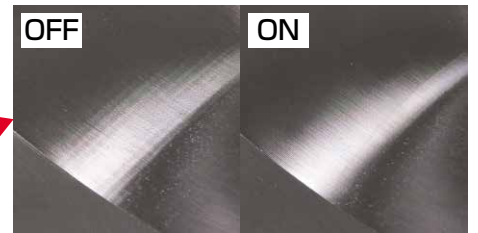
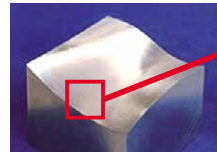

Example of smooth tolerance+ control  
\* Program with CAM tolerance 5  $\mu\text{m}$

## Stable machining

- Thermal displacement compensation function
  - Real time compensation by estimating the thermal displacement based on the operation status of the spindle and feed axes
  - By using touch probe (option), compensation effect adjustment can be performed automatically from the measurement result.
- AI thermal displacement compensation function II (Option)
  - Thermal displacement is estimated precisely with the temperature sensors equipped around spindle head and column.
  - Stable compensation against temperature change between day and night or seasons.
  - Even if some of sensors got trouble, sensor check function will keep proper compensation.



AI thermal displacement compensation

## Machining Capability

	Machining	Drilling Tool dia.(mm) x Feed(mm/rev)			Tapping Tap size x Tap pitch(mm)		
	Material	S50C	FC200	ADC12	S50C	FC200	ADC12
Spindle spec.	Standard	Dia.30 x 0.10	Dia.30 x 0.25	Dia.32 x 0.35	M20 x 2.5	M27 x 3.0	M30 x 3.5
	High-torque	Dia.30 x 0.15	Dia.30 x 0.30	Dia.32 x 0.40	M20 x 2.5	M27 x 3.0	M30 x 3.5
	Tapping	Dia.25 x 0.15		Dia.32 x 0.30	M18 x 2.5		M27 x 3.0
	High-acceleration	Dia.20 x 0.10		Dia.22 x 0.25	M16 x 2.0		M24 x 3.0
	High-speed	Dia.20 x 0.10		Dia.22 x 0.25	M16 x 2.0		M24 x 3.0

\* These data may change by cutting tools or machining conditions.

# Maximizing Uptime

## High-reliability

- Endeavor to enhance reliability
  - Reliability oriented product development under the slogan of “Reliable, Predictable, Easy to Repair”
  - Promoting further improvement of reliability by FANUC’s original reliability development method such as accelerated life test
- Reliability evaluation building
  - Simultaneous multiple accelerated life tests are carried out in the vast experiment area
  - Dedicated test rooms such as anechoic chamber, EMS test room, vibration test room, etc. are utilized for evaluation tests under various conditions
- Abundant track records at FANUC in-house factory
  - More than 200 units of ROBODRILLs are working 24 hours at FANUC in-house factory for both steel and aluminum parts machining
  - Achieving High-reliability by analyzing the operation and maintenance data and returning to ROBODRILL design

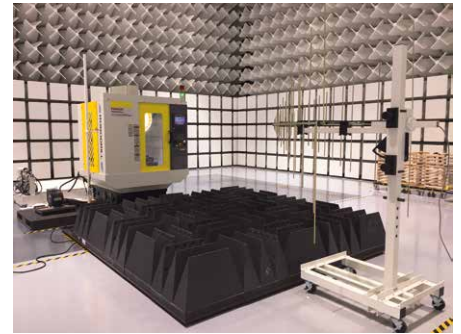

EMC test in anechoic chamber



FANUC in-house factory

## ROBODRILL-LINK*i* (PC software)

- Operation condition monitoring system
  - Real time display of the entire production area helps to understand the condition of each machine at once
  - Supporting improvement of machine utilization by collecting each machine’s information and displaying in the graph
- Easy introduction
  - The system can be built with general PC and no server PC is required
- Useful tools for management of ROBODRILLs
  - Collecting ROBODRILL’s additional information such as periodical maintenance data, tool life, etc.
  - Making Backup of machining program, parameter, etc.
  - NC program can be transferred to multiple ROBODRILLs simultaneously

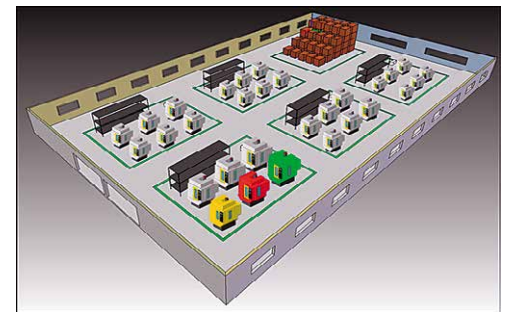

Condition overlook screen

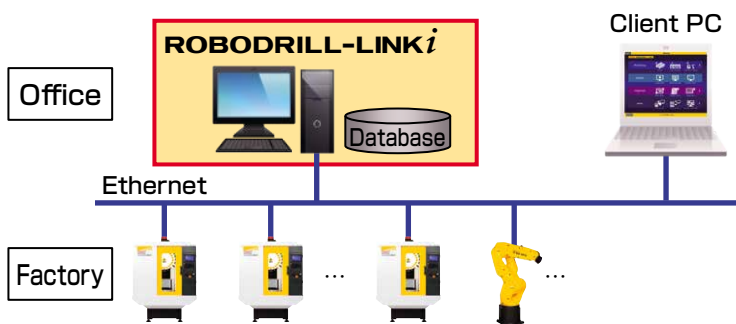

Connection example



Individual machine operation achievement

## Complete preventive maintenance

- Maintenance information management
  - Monitoring the condition of maintenance items and announcing the abnormality or maintenance timing to support effective periodical maintenance
  - Maintenance items can be customized (up to 10)
- Leakage Detection Function
  - Early detection of insulation resistance drop of each motor and motor power cable
  - Enable preventive maintenance before breakdown
- Fan Monitor Function
  - Monitoring cooling fans of CNC, Servo Amplifiers, Spindle Amplifier and Power Supply
  - Announcing before failure when the rotation speed of the cooling fans is dropping
  - Easy to detect the abnormal fan

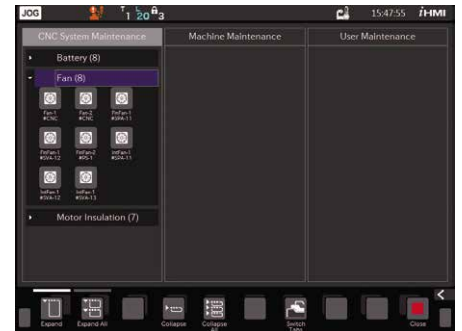

Maintenance information management screen



Fan monitor screen

## High-maintainability

- Recovery guidance screens
  - Easy to recover the turret position, motor origin, etc. by following instructions in each screen in case of accident
- Improvement of maintainability for I/O device
  - Cause and point of the failure of I/O devices (disconnection, earth fault etc.) are identified by CNC
- Machine configuration to improve parts replacement
  - Cartridge type fan motor units realizes easy parts replacement
- Rechargeable battery unit (option)
  - Supplying backup power both CNC and Pulseorder
  - Automatically recharged while ROBODRILL power ON and battery maintenance free

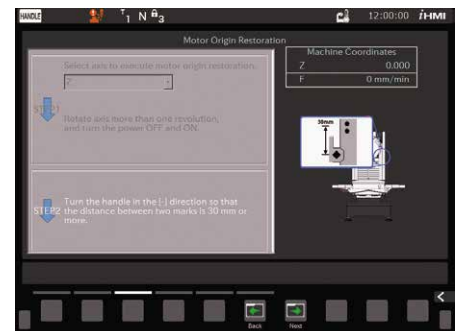

Motor origin restoration screen

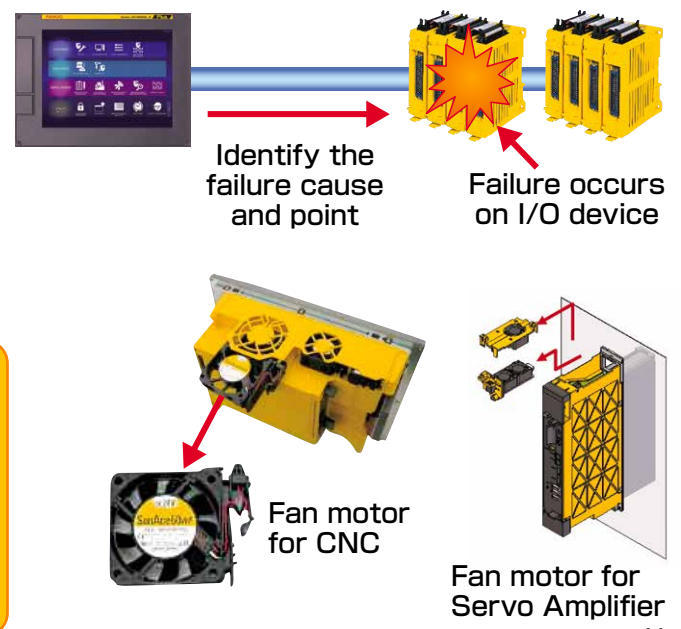

# Ease of Use

## High-usability

- Operator's panel with 10.4" Color LCD for **iHMI**
  - Intuitive and operable interface by **iHMI**
  - Seamless flat display unit with high-resistance to coolant oil
  - Touch panel type display (option) is available
- Supporting PDCA cycle by **iHMI** CNC operation screen
  - A series of works from programming to machining are realized in one screen
  - Easy to make program through graphic guidance (**iHMI** Machining Cycle)
  - Easy to check program by machining simulation with 3D solid model
  - Various measurement cycles with touch probe are available (**iHMI** Set-up Guidance)



**iHMI** CNC operation screen



**iHMI** Machining Cycle

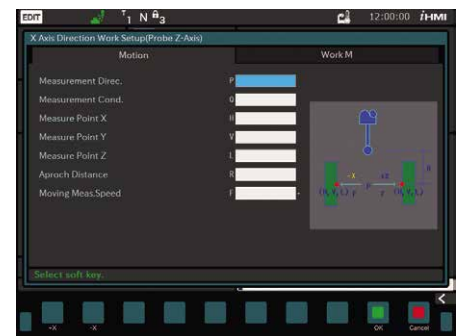

**iHMI** Set-up Guidance

## Automation with Robot

- Robot interface 2 (option)
  - System start/stop, operation status check, robot manual operation, etc. are available on screen
  - Easy to connect Robodrill and robot by easy setting function
  - Safety function and less wires connection by FL-net
- **ROBODRILL** Robot Package (option)
  - Package of basic elements of robot system such as robot, robot base, automatic side door, consolidated connecting cable, Robot interface 2, sample programs of robot, etc.
  - Easy to setup robot system as Robodrill and robot are connected at delivery.



operation status screen



Robot manual operation screen



Application Example

## High-expandability

- External interface function
  - General I/O signals for fixture and peripheral control are ready to use only by assigning in the screen
  - Lighting conditions of signal lamps can be set on the screen
- Custom PMC function
  - Ladder program to control peripheral devices can be created without adding any external sequencer unit
  - Custom PMC Ladder can be edited and monitored on screen
  - I/O signals: Input 16 / Output 16 (standard)  
Input 1024 / Output 1024 (option, maximum)
- Custom PMC for DCS
  - Safety I/O signals of peripherals can be connected (Input 12 / Output 8)
  - Software safety circuit can be developed by duplicated signals with Custom PMC function
- Custom control panel
  - Control switches (ON/OFF or pulse) and indication lamps can be created on screen without hardware
  - Operability of peripherals can be improved without cost
- Custom screen
  - Up to 15 applications developed with FANUC PICTURE (PC software) can be registered
  - Usable to control peripheral devices by linking Custom PMC function
  - Various exclusive screens for peripheral devices are provided from their suppliers
- Favorite screen
  - Shortcuts of frequently used screens can be registered



External interface function

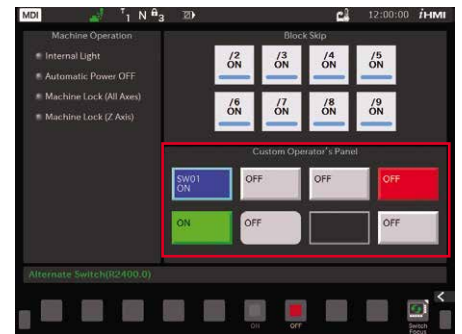

Custom control panel



Examples of Custom screen

## Conformity of safety standards

- Dual check safety
  - Securing operators by duplicating safety I/O signals such as emergency stop and door switch
- Safe torque off (STO) function
  - Power between motors and amplifiers are certainly stopped by using safe torque signal

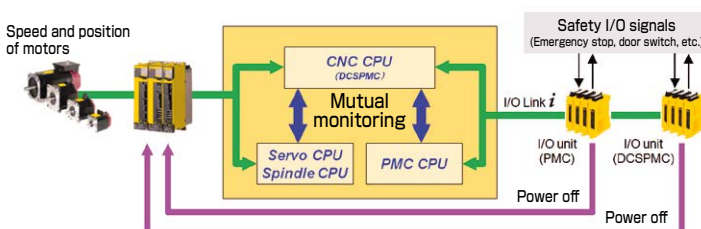

- Conformity of major safety standards (option)

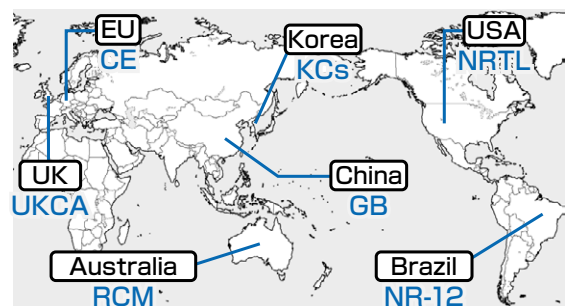

# Options

## FANUC ROBODRILL DDRi<sup>®</sup>

- High-speed and high-precision additional 1-axis rotary table **DDRi<sup>®</sup>**
  - Synchronous built-in servo motor and  $\alpha$ iCZ sensor provide non-backlash, high-speed and high-precision machining.
- Trunnion unit with **DDRi<sup>®</sup>** and support spindle for quick setup of indexing fixture **DDR-Ti<sup>®</sup>**
  - Easy to setup fixture by making the best use of ROBODRILL's working space
- High-speed rotary table for turning **DDR-HSi<sup>®</sup>**
  - Max. speed 1,500min<sup>-1</sup> and Max. torque 100N · m
  - High-precision and high-quality turning is available with CNC functions for turning

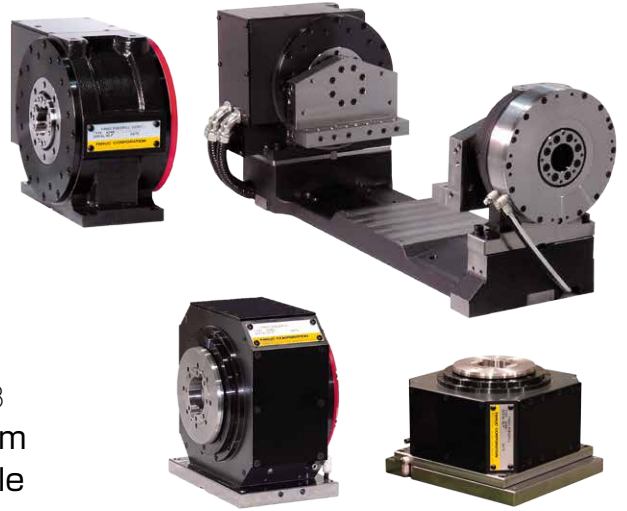

\* For detailed information, please see the catalogue of **DDRi<sup>®</sup>**, **DDR-Ti<sup>®</sup>** or **DDR-HSi<sup>®</sup>**

## Main options



Coolant unit (tank)



Coolant unit with chip flush (with oil gun)

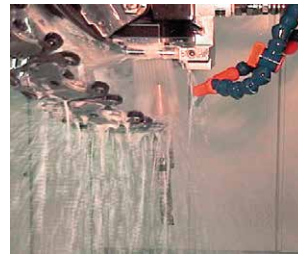

Cleaning unit for tool taper shank



Top cover



LED Illumination



Tool length switch for automatic measurement



Automatic Grease Lubricating System (LHL Liquid Grease)



Touch probe



Signal lamp



Automatic Oil Lubricating System



Automatic Grease Lubricating System (LHL Liquid Grease)



Portable manual pulse generator



Rechargeable battery unit

(Note)

- The machine life may be shortened depending on the workpiece, tool, coolant, or lubricant to be used.

# Function list

Standard specifications	
Control unit FANUC Series 31i-B5 Plus Simultaneously controlled axes (Max. 5 axes) Multi-function Ethernet*1 Control unit incorporated type display unit with 10.4" color LCD*2 PCMCIA memory card port USB port (USB2.0) Part program storage size 4Mbyte Number of registerable programs 1000 Addition of workpiece coordinate system 48 pairs Tool offset pairs 200-pairs Tool life management Production control counter iHMI Set-up Guidance (MANUAL GUIDE <i>i</i> on <i>i</i> HMI) Machining Mode Setting Thermal displacement compensation function Custom PMC	Dual check safety Smart Trouble Shooting Function Leakage Detection Function Backup function for power failure (quick stop function)*3 Smart rigid tapping Spindle Smart Load Meter AI contour control I HRV control Rapid traverse block overlap Helical interpolation Coordinate system rotation Tool offset Multi-step skip High-speed skip Custom macro Interruption type custom macro
Mechanical Option (Note) Some options are not applicable depending on machine model and configurations.	
High torque spindle 10,000min <sup>-1</sup> , High acceleration spindle 10,000min <sup>-1</sup> Tapping spindle 12,000min <sup>-1</sup> , High speed spindle 24,000min <sup>-1</sup> Low vibration High speed spindle 24,000min <sup>-1</sup> High power version spindle Double contact tooling (BBT30/NBT30) Center through spindle (7MPa) High column (100/200/300/400mm)*4 Splashguard wide opening door *5 Automatic front door opening/closing of splashguard Automatic side door of splashguard (right/left) Splashguard glass window (window size is smaller) Basic top cover of splashguard/Full-closed cover of splashguard *6 Color specification X-axis telescopic cover with 3-pieces *7 Z-axis metal cover *7 Additional 1 axis rotary table DDRiB/DDR-TiB/DDR-HSiB (C-axis installation/Horizontal axis installation)	Rotary joint for DDRiB/Tail support (Standard type) Rotary joint for DDRiB/Tail support (High pressure type) Rotary joint for DDR-HSiB (Hydraulic type) Adjustment of center height, Adjustment of shaft length, End plate (for DDRiB) Coolant unit (Tank capacity : 100/200/140*8 L) Coolant unit for center through coolant (Tank capacity : 240/200*8 L, Pressure : 1.5MPa) Coolant unit with chip flush (with oil gun) Cleaning unit for tool taper shank Excellent chip evacuation Air blow for chips Grip cover Automatic oil lubricating/Automatic grease lubricating Illumination (LED) Signal lamp (3 lamps) Tool length switch Touch probe
Electric Option (Note) Some options are not applicable depending on machine model and configurations.	
Additional controlled 1 axis (Simultaneously controlled 4 axes) Additional controlled 2 axes (Simultaneously controlled 5 axes) Conformity to safety standards for EU (CE), China (GB), Korea (KCs), UK(UKCA), US(NRTL), Australia (RCM) and Brasil (NR-12) Automatic breaker shutdown Backup function for power failure (quick stop function)*3 Power cable (length : 5/12/3*9 m) Mounting plate for options	Various additional I/O unit CNC with touch panel LCD Network adapter (DeviceNet, PROFIBUS-DP, CC-Link) Fast data server (with Compact Flash Memory 4GB) ROBOT INTERFACE 2 Portable MPG (with ESP switch) RS-232C port Rechargeable battery unit
Software Option (Note) Some options are not applicable depending on machine model and configurations.	
AI thermal displacement compensation II AI tool monitoring Part program storage size 8Mbyte Number of registerable programs 4000 Addition of workpiece coordinate system 300 pairs Tool management function (1000 pairs) 3D interference check Single direction positioning Conical/spiral interpolation Involute interpolation Cylindrical interpolation Polar coordinate command Scaling Programmable mirror image	AI contour control II High-speed processing Look-ahead blocks expansion (1000 blocks) Smooth tolerance+ control NURBUS interpolation High-speed smooth TCP Work setting error compensation 3-dimensional cutter compensation 3-dimensional coordinate conversion Tilted working plane indexing command Punch tapping function Smart spindle load control Quick program restart Turning function
PC Software	
ROBODRILL-LINK <i>i</i> ROBODRILL-CNCGuide FANUC SERVO VIEWER	FANUC LADDER-III FANUC PICTURE Program transfer tool

\*1 Fast Ethernet is embedded on CNC main board. Available network functions: FL-net, Ethernet/IP, PROFINET IO, Modbus/TCP

\*2 The color LCD screen may have a few missing or constantly lit pixels.

\*3 This function is standard for Advanced version and option for Standard version.

\*4 Max 200mm for X-axis stroke 300mm, Max 300mm for X-axis stroke 500mm and 700mm of Standard version

\*5 Opening width is 730mm for X-axis stroke 500mm and 1100mm for X-axis stroke 700mm. It is standard for X-axis stroke 300mm.

\*6 Mist collector must be used together.

\*7 Only for Standard version

\*8 In case of X-axis stroke 300mm

\*9 In case of the compliance with safety regulation (except for NRTL, RCM and NR-12)

# Specification

Item		$\alpha$ -D21SiB5 Plus $\alpha$ -D14SiB5 Plus	$\alpha$ -D21MiB5 Plus $\alpha$ -D14MiB5 Plus	$\alpha$ -D21LiB5 Plus $\alpha$ -D14LiB5 Plus
Machine (Standard)				
Capacity	X-axis travel (longitudinal movement of table)	300 mm	500 mm	700 mm
	Y-axis travel (cross movement of saddle)	300 mm + 100 mm	400 mm	
	Z-axis travel (vertical movement of spindle head)	330 mm		
	Distance from table surface to spindle gage plane	150 mm to 480 mm (when no high column is specified)		
Table	Working space (X-axis×Y-axis)	630 mm×330 mm	650 mm×400 mm	850 mm×410 mm
	Capacity of workpiece mass	200 kg (uniform load)	300 kg (uniform load)	
	Working surface configuration	3 x T-slots size 14 mm pitch 125 mm		
Spindle	Speed range	100 min <sup>-1</sup> to 10000 min <sup>-1</sup> 100 min <sup>-1</sup> to 12000 min <sup>-1</sup> / 240 min <sup>-1</sup> to 24000 min <sup>-1</sup> (option)		
	Spindle gauge (Call number) *1	7/24 taper No.30 (with air blow)		
Feedrate	Rapid traverse rate	54 m/min (X, Y, Z)		
	Cutting feedrate	1 mm/min to 30000 mm/min		
Turret	Type of tooling / Type of pull stud bolt	JIS B 6339-2 No.30 / MAS 403-1982 P30T-1 (45°) *2		
	Tool storage capacity	21 tools : $\alpha$ -D21SiB5 Plus / D21MiB5 Plus / D21LiB5 Plus 14 tools : $\alpha$ -D14SiB5 Plus / D14MiB5 Plus / D14LiB5 Plus		
	Maximum tool diameter	80 mm		
	Maximum tool length	200 mm (changes by specifications)	250 mm (changes by specifications)	
	Maximum tool mass [Total mass]	2 kg [23 kg] / 3 kg [33 kg] : 21 tools 2 kg [15 kg] / 3 kg [22 kg] : 14 tools		
	Tool changing time (Cut to Cut)	1.6 s (2 kg setting) : 21 tools 1.4 s (2 kg setting) : 14 tools		
Motors	Spindle drive motor	11.0 kW (1 minute rating) / 3.7 kW(continuous rating) (changes by specifications)		
Accuracy *3	Bidirectional accuracy of positioning of an axis	Less than 0.006 mm (ISO230-2:1988)		
	Bidirectional repeatability of positioning of an axis	Less than 0.004 mm (ISO230-2:1997,2006)		
Sound pressure level		Less than 70 dB *4		
Control unit		<b>FANUC Series 31i-B5 Plus</b> (Simultaneously controlled axes: Max.5 axes)		
Installations	(note) Please make sure to comply with	installation conditions specified by FANUC when installing ROBODRILL *5		
Power source	Power supply	200V AC. to 220V AC., - 15 % to + 10 %, 3-phase, 50 Hz±1 Hz or 60 Hz±1 Hz Standard/High-torque/High-torque (High-power version)/High-acceleration/High-speed: 10kVA, High-acceleration/High-speed (High-power version): 12kVA, Tapping: 18kVA *6		
	Compressed air supply	0.35 MPa to 0.55 MPa (0.5 MPa is recommend) (gage pressure), 0.16 m <sup>3</sup> /min (at atmospheric pressure) *7		
Machine size	Machine height	2236 mm ± 10 mm (when no high column is specified)		
	Floor space	995 mm×2210 mm	1615 mm×2040 mm	2165 mm×2040 mm
	Mass of machine	Approx. 1950 kg	Approx. 2000 kg	Approx. 2100 kg

\*1 Spindle gauge does not conform to JIS B 6340:1992, JIS B 6340-1:2019 or JIS B 6340-2:2019.

\*2 In case of using center through coolant, please apply suitable pull stud bolt for Robodrill of each tooling supplier.

\*3 Positioning accuracy is the adjusted and measured value in compliance with applicable standard at FANUC's factory. Depending on an influence of JIG & workpiece mass on table, the use conditions and installation environment, there may be a case where the accuracy shown in this catalog can not be achieved.

\*4 Sound pressure level is measured in compliance with FANUC's own regulation. Depending on the use conditions and installation environment, there may be a case where the sound pressure level shown in this catalog can not be achieved.

\*5 Fastening the machine to the floor (mounting anchors) may be required depending on the use conditions and installation environment, or to prevent the machine from toppling over due to an earthquake.

\*6 When peripherals such as coolant unit or rotary table are added, additional power is required. Please contact FANUC for detail. A cable with 10 mm<sup>2</sup>~14mm<sup>2</sup> should be used at primary power connection.

\*7 In case of center through coolant, additional + 0.05 m<sup>3</sup>/min is required. In case of air blow for chips, additional + 0.2 m<sup>3</sup>/min is required. In case of side automatic door, 0.4 MPa compressed air supply or more is required.



## α-D14/21SiB5 Plus

\*1

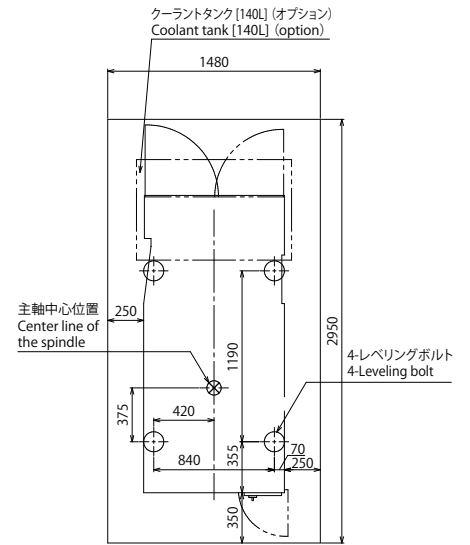
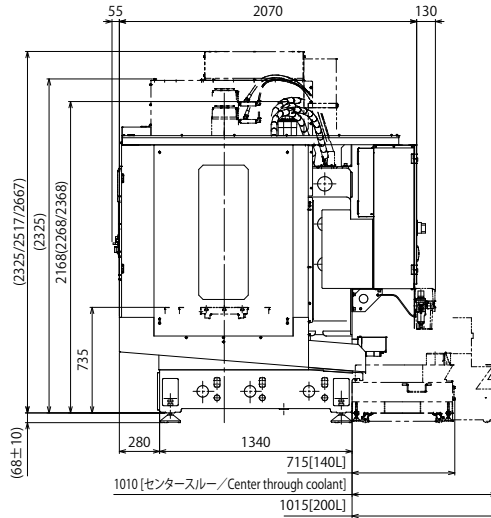
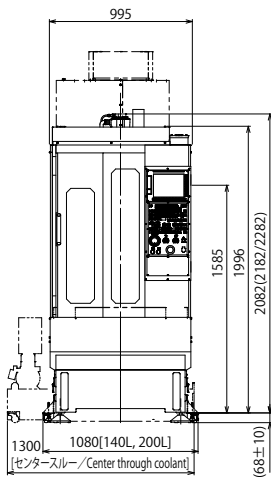

## α-D14/21MiB5 Plus

\*1

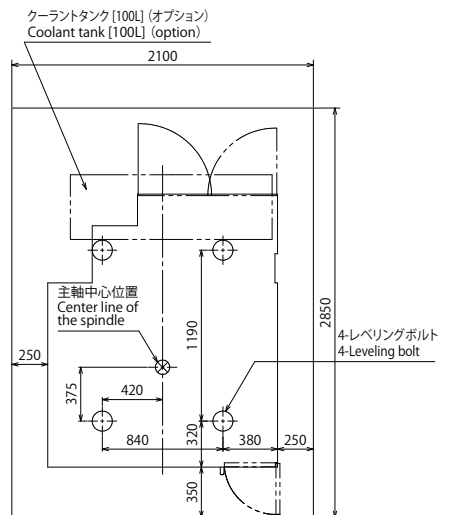
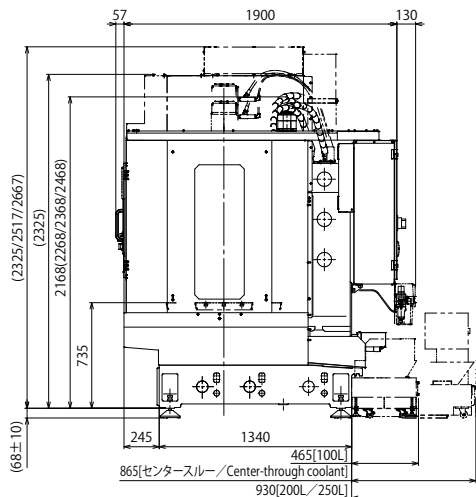
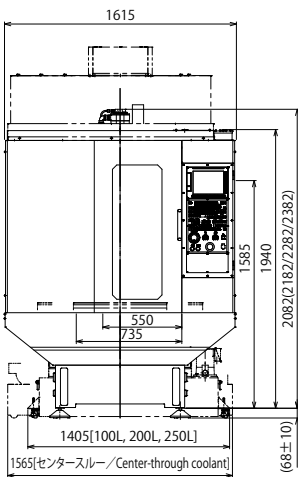

## α-D14/21LiB5 Plus

\*1

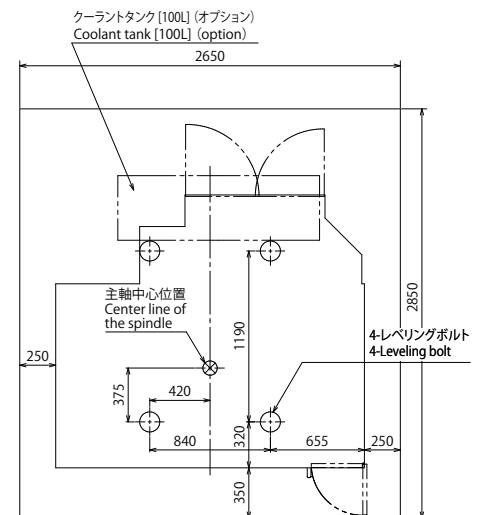
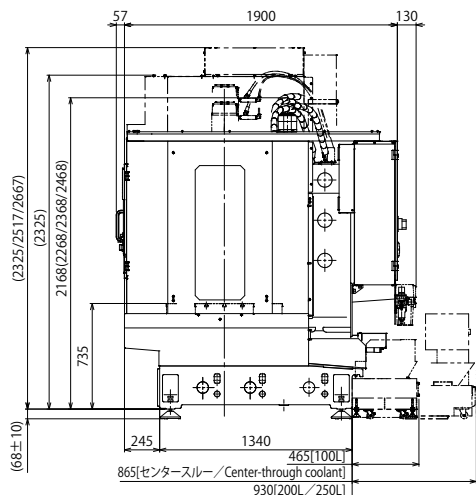
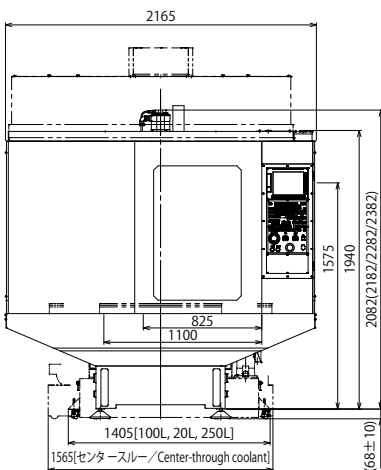

\*1 These dimensions may change by adding options. (For further details, please contact FANUC.)

# Specification

Item		$\alpha$ -D21SiB5 <sub>ADV</sub> Plus	$\alpha$ -D28MiB5 <sub>ADV</sub> Plus	$\alpha$ -D28LiB5 <sub>ADV</sub> Plus Y500
		$\alpha$ -D14SiB5 <sub>ADV</sub> Plus	$\alpha$ -D21MiB5 <sub>ADV</sub> Plus	$\alpha$ -D21LiB5 <sub>ADV</sub> Plus Y500
Machine (Standard)				
Capacity	X-axis travel (longitudinal movement of table)	300 mm	500 mm	700 mm
	Y-axis travel (cross movement of saddle)	300 mm + 100 mm	400 mm	500 mm
	Z-axis travel (vertical movement of spindle head)	400 mm		
	Distance from table surface to spindle gage plane	80 mm to 480 mm (when no high column is specified)		
Table	Working space (X-axis×Y-axis)	630 mm×330 mm	650 mm×400 mm	850 mm×500 mm
	Capacity of workpiece mass	200 kg (uniform load)	400 kg (uniform load)	
	Working surface configuration	3 x T-slots size 14 mm pitch 125 mm		
Spindle	Speed range	100 min <sup>-1</sup> to 10000 min <sup>-1</sup> 100 min <sup>-1</sup> to 12000 min <sup>-1</sup> / 240 min <sup>-1</sup> to 24000 min <sup>-1</sup> (option)		
	Spindle gauge (Call number) *1	7/24 taper No.30 (with air blow)		
Feedrate	Rapid traverse rate	54 m/min (X, Y, Z)		54 m/min (X,Y), 60 m/min (Z)
	Cutting feedrate	1 mm/min to 30000 mm/min		
Turret	Type of tooling / Type of pull stud bolt	JIS B 6339-2 No.30 / MAS 403-1982 P30T-1 (45°) *2		
	Tool storage capacity	28 tools : $\alpha$ -D28MiB5 <sub>ADV</sub> Plus / D28LiB5 <sub>ADV</sub> Plus Y500 21 tools : $\alpha$ -D21SiB5 <sub>ADV</sub> Plus / D21MiB5 <sub>ADV</sub> Plus / D21LiB5 <sub>ADV</sub> Plus Y500 14 tools : $\alpha$ -D14SiB5 <sub>ADV</sub> Plus / D14MiB5 <sub>ADV</sub> Plus / D14LiB5 <sub>ADV</sub> Plus Y500		
	Maximum tool diameter	80 mm		
	Maximum tool length	200 mm (changes by specifications)	250 mm	
	Maximum tool mass [Total mass]	1.5 kg [24 kg] / 2 kg [30 kg] / 3 kg [38 kg] / 4 kg [46kg] : 28 tools 2 kg [23kg] / 3 kg [33 kg] / 4 kg [46 kg] : 21 tools 2 kg [15kg] / 3 kg [22 kg] / 4 kg [30 kg] : 14 tools		
	Tool changing time (Tool to Tool)	0.7 s (1.5 kg setting) / 0.8 s (2 kg setting) / 1.0 s (3 kg setting) / 1.1 s (4 kg setting) : 28 tools 0.7 s (2 kg setting) / 0.9 s (3 kg setting) / 1.1 s (4 kg setting) : 21/14 tools		
	Tool changing time (Cut to Cut)	1.3 s (1.5 kg setting) / 1.5 s (2 kg setting) / 1.7 s (3 kg setting) / 1.8 s (4 kg setting) : 28 tools 1.3 s (2 kg setting) / 1.5 s (3 kg setting) / 1.7 s (4 kg setting) : 21/14 tools		
Motors	Spindle drive motor	11.0 kW (1 minute rating) / 3.7 kW(continuous rating) (changes by specifications)		
Accuracy *3	Bidirectional accuracy of positioning of an axis	Less than 0.006 mm (ISO230-2:1988)		
	Bidirectional repeatability of positioning of an axis	Less than 0.004 mm (ISO230-2:1997,2006)		
Sound pressure level		Less than 70 dB *4		
Control unit		FANUC Series 31i-B5 Plus (Simultaneously controlled axes: Max.5 axes)		
Installations (note) Please make sure to comply with		installation conditions specified by FANUC when installing ROBODRILL *5		
Power source	Power supply	200V AC. to 220V AC., -15% to +10%, 3-phase, 50 Hz±1 Hz or 60 Hz±1 Hz Standard/High-torque/High-torque (High-power version)/High-acceleration/High-speed: 10kVA, High-acceleration/High-speed (High-power version): 12kVA, Tapping: 18kVA *6		
	Compressed air supply	0.35 MPa to 0.55 MPa (0.5 MPa is recommend) (gage pressure), 0.16 m <sup>3</sup> /min (at atmospheric pressure) *7		
Machine size	Machine height	2236 mm ± 10 mm (when no high column is specified)		
	Floor space	995 mm×2220 mm	1615 mm×2050 mm	2165 mm×2115 mm
	Mass of machine	Approx. 2200 kg	Approx. 2250 kg	Approx. 2450 kg

\*1 Spindle gauge does not conform to JIS B 6340:1992, JIS B 6340-1:2019 or JIS B 6340-2:2019.

\*2 In case of using center through coolant, please apply suitable pull stud bolt for Robodrill of each tooling supplier.

\*3 Positioning accuracy is the adjusted and measured value in compliance with applicable standard at FANUC's factory. Depending on an influence of JIG & workpiece mass on table, the use conditions and installation environment, there may be a case where the accuracy shown in this catalog can not be achieved.

\*4 Sound pressure level is measured in compliance with FANUC's own regulation. Depending on the use conditions and installation environment, there may be a case where the sound pressure level shown in this catalog can not be achieved.

\*5 Fastening the machine to the floor (mounting anchors) may be required depending on the use conditions and installation environment, or to prevent the machine from toppling over due to an earthquake.

\*6 When peripherals such as coolant unit or rotary table are added, additional power is required. Please contact FANUC for detail. A cable with 10 mm<sup>2</sup>~14mm<sup>2</sup> should be used at primary power connection.

\*7 In case of center through coolant, additional + 0.05 m<sup>3</sup>/min is required. In case of air blow for chips, additional + 0.2 m<sup>3</sup>/min is required. In case of side automatic door, 0.4 MPa compressed air supply or more is required.

## α-D14/21SiB5<sub>ADV</sub> Plus

\*1

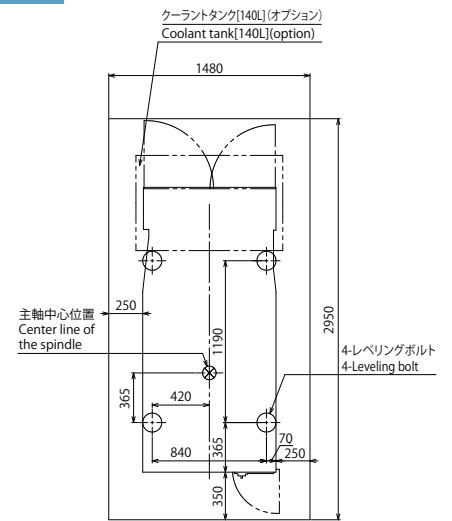
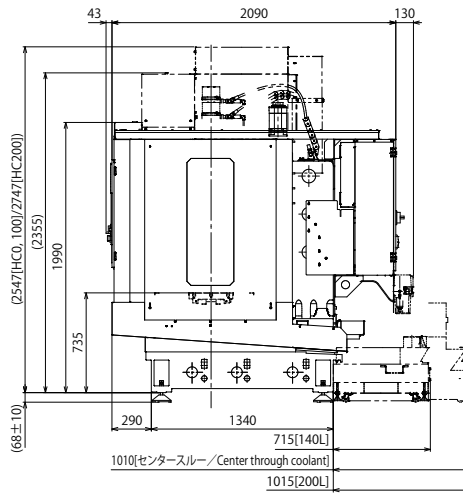
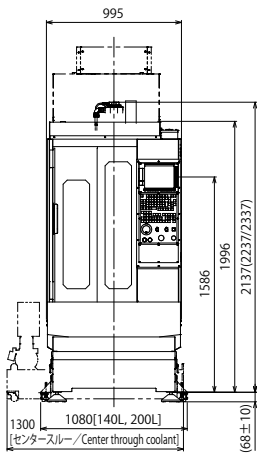

## α-D14/21/28MiB5<sub>ADV</sub> Plus

\*1

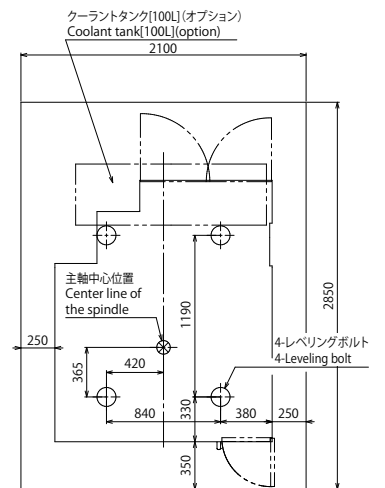
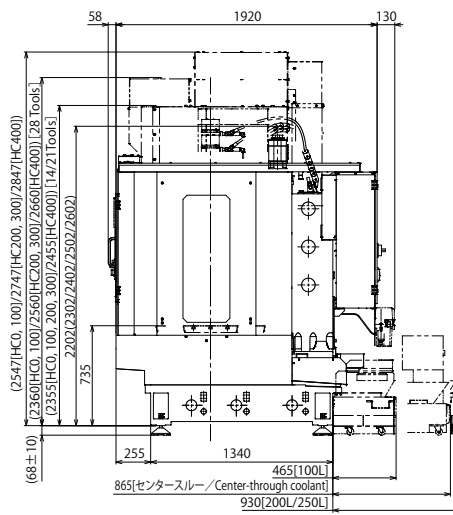
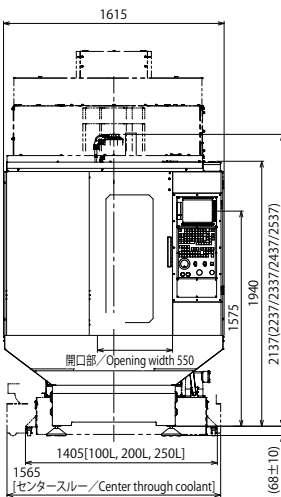

## α-D14/21/28LiB5<sub>ADV</sub> Plus Y500

\*1

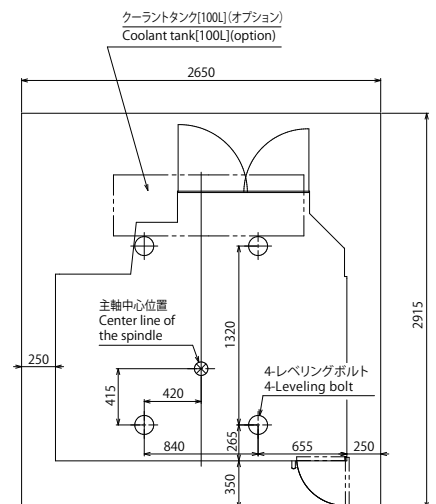
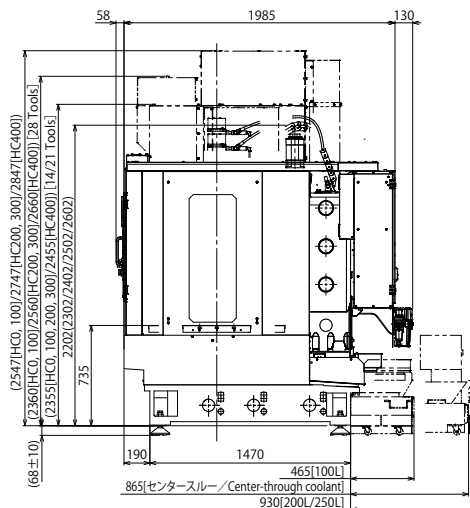
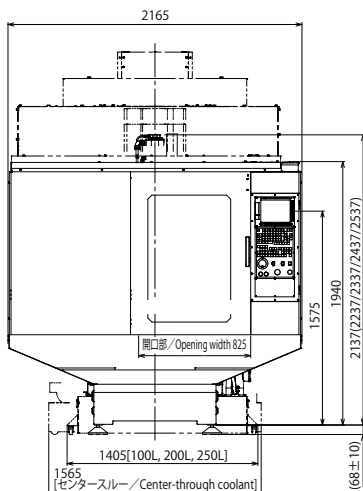

\*1 These dimensions may change by adding options. (For further details, please contact FANUC.)

# Service & Support

## Excellent Maintenance Services

FANUC service team delivers customer trust and confidence based on direction of service "Maximizing Uptime", "Global Service" and "Lifetime maintenance".

### Service First

Conforming to the spirit of "Service First", FANUC provides lifetime maintenance to its products for as long as they are used by customers, through more than 270 service locations supporting more than 100 countries and regions throughout the world.

Maximizing Uptime



## FANUC ACADEMY

FANUC ACADEMY operates training programs on FANUC ROBOTDRILL which focus on practical operations and programming with machining know-how and maintenance.



## Lifetime maintenance

FANUC offers lifetime maintenance, where FANUC's products will be serviced as long as they are used by customers. The motors, PCBs or any units of even over thirty years old can be repaired and recovered.

To perform lifetime maintenance, FANUC stocks enough amount of discontinued spare parts and even redesigns units when spare parts have run out.



TAPE CENTER-MODEL D  
(1978~1986)

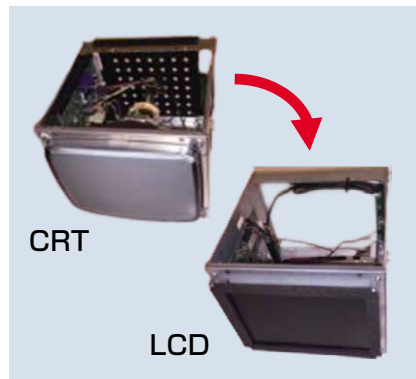

Redesign of CRT display



FANUC Repair factory

Алматы (7273)495-231  
Ангарск (3955)60-70-56  
Архангельск (8182)63-90-72  
Астрахань (8512)99-46-04  
Барнаул (3852)73-04-60  
Белгород (4722)40-23-64  
Благовещенск (4162)22-76-07  
Брянск (4832)59-03-52  
Владивосток (423)249-28-31  
Владикавказ (8672)28-90-48  
Владимир (4922)49-43-18  
Волгоград (844)278-03-48  
Вологда (8172)26-41-59  
Воронеж (473)204-51-73  
Екатеринбург (343)384-55-89

Иваново (4932)77-34-06  
Ижевск (3412)26-03-58  
Иркутск (395)279-98-46  
Казань (843)206-01-48  
Калининград (4012)72-03-81  
Калуга (4842)92-23-67  
Кемерово (3842)65-04-62  
Киров (8332)68-02-04  
Коломна (4966)23-41-49  
Кострома (4942)77-07-48  
Краснодар (861)203-40-90  
Красноярск (391)204-63-61  
Курск (4712)77-13-04  
Курган (3522)50-90-47  
Липецк (4742)52-20-81  
Россия +7(495)268-04-70

Магнитогорск (3519)55-03-13  
Москва (495)268-04-70  
Мурманск (8152)59-64-93  
Набережные Челны (8552)20-53-41  
Нижний Новгород (831)429-08-12  
Новокузнецк (3843)20-46-81  
Ноябрьск (3496)41-32-12  
Новосибирск (383)227-86-73  
Омск (3812)21-46-40  
Орел (4862)44-53-42  
Оренбург (3532)37-68-04  
Пенза (8412)22-31-16  
Петрозаводск (8142)55-98-37  
Псков (8112)59-10-37  
Пермь (342)205-81-47  
Казахстан +7(7172)727-132

Ростов-на-Дону (863)308-18-15  
Рязань (4912)46-61-64  
Самара (846)206-03-16  
Санкт-Петербург (812)309-46-40  
Саратов (845)249-38-78  
Севастополь (8692)22-31-93  
Саранск (8342)22-96-24  
Симферополь (3652)67-13-56  
Смоленск (4812)29-41-54  
Сочи (862)225-72-31  
Ставрополь (8652)20-65-13  
Сургут (3462)77-98-35  
Сыктывкар (8212)25-95-17  
Тамбов (4752)50-40-97  
Тверь (4822)63-31-35  
Киргизия +996(312)96-26-47

Тольятти (8482)63-91-07  
Томск (3822)98-41-53  
Тула (4872)33-79-87  
Тюмень (3452)66-21-18  
Ульяновск (8422)24-23-59  
Улан-Удэ (3012)59-97-51  
Уфа (347)229-48-12  
Хабаровск (4212)92-98-04  
Чебоксары (8352)28-53-07  
Челябинск (351)202-03-61  
Череповец (8202)49-02-64  
Чита (3022)38-34-83  
Якутск (4112)23-90-97  
Ярославль (4852)69-52-93